

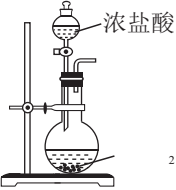

化 学 试 题

注意事项：

一、选择题：本题共 2 小题，每小题 5 分，共 10 分。每小题只有一个选项符合题目要求。

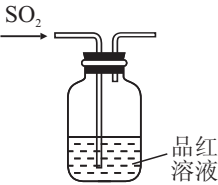

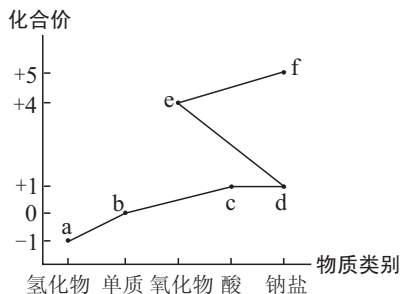
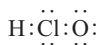

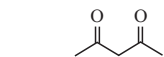
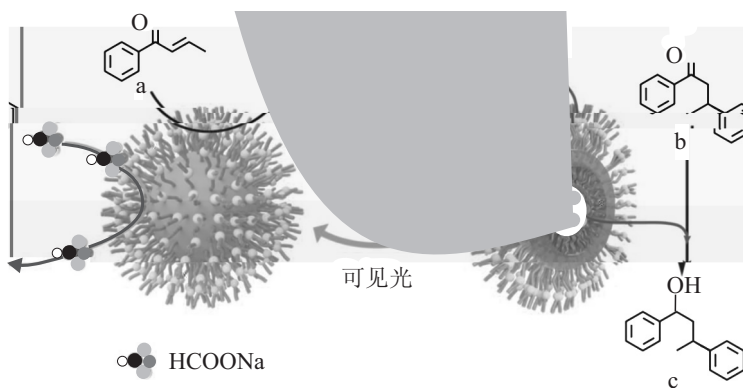
N

N

N

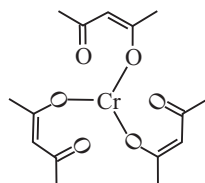

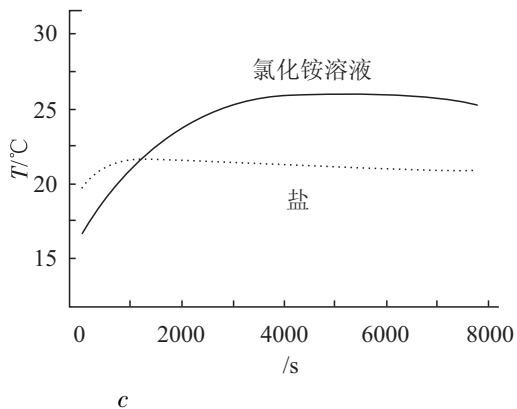
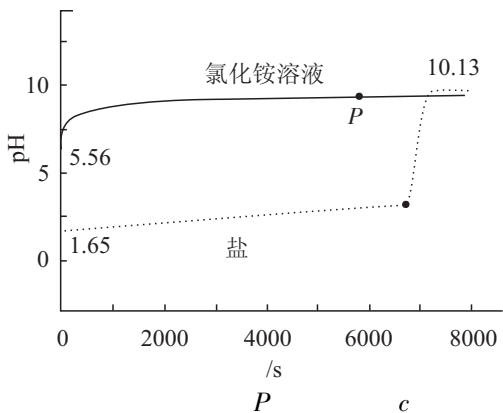

K

Q

二、非选择题：本题共 小题，共 分。

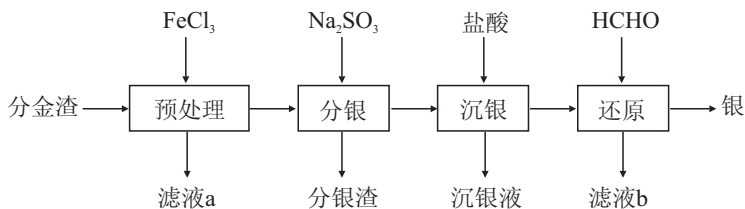

K

K

K

K

c

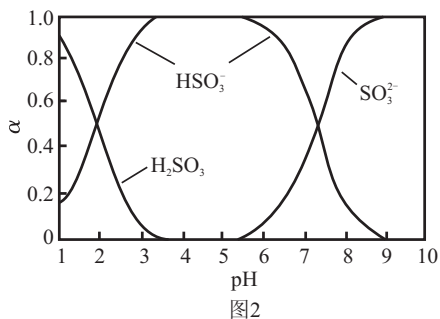
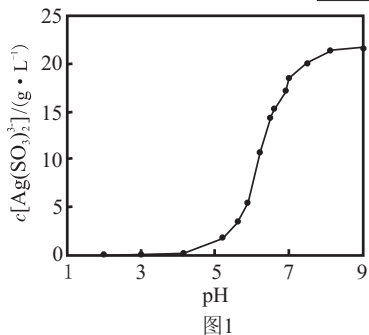

()



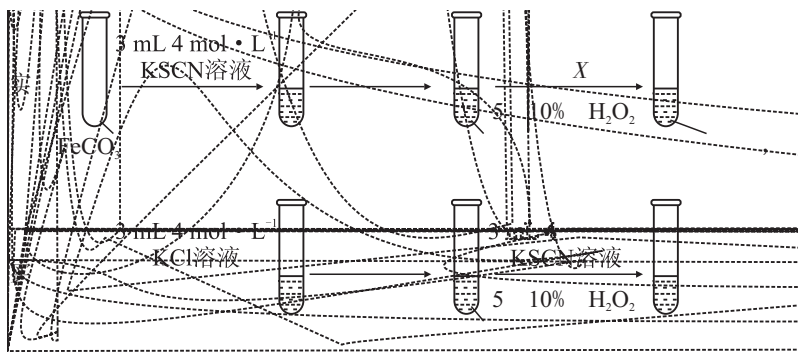

X

H
H

H

v v

()

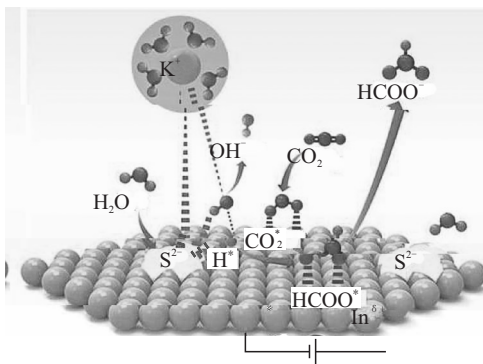

图a

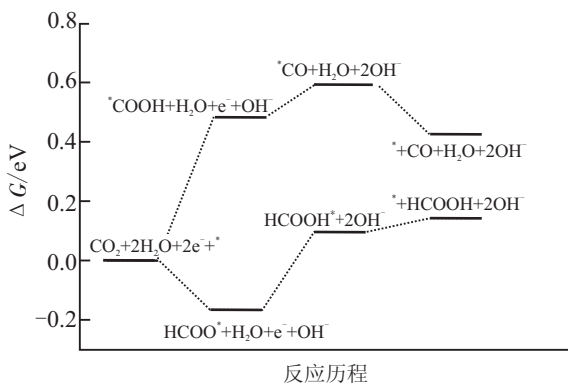

图b

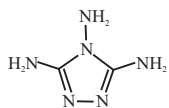
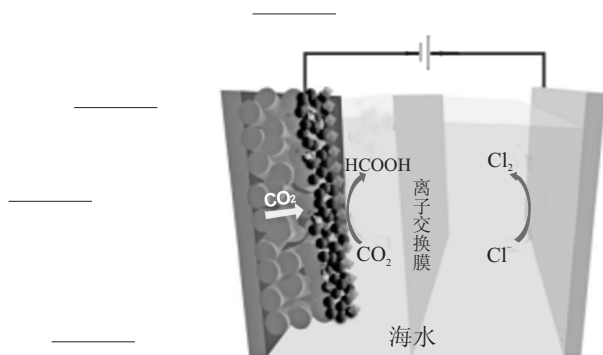

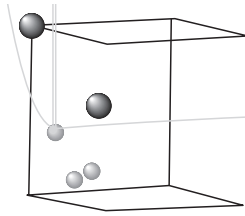
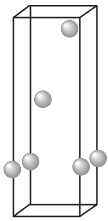

M

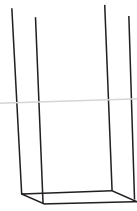

N

